

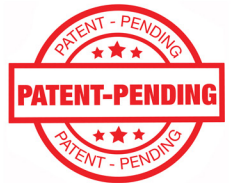

INSTALLATION AND OWNER'S INSTRUCTIONS

NET PROTECT

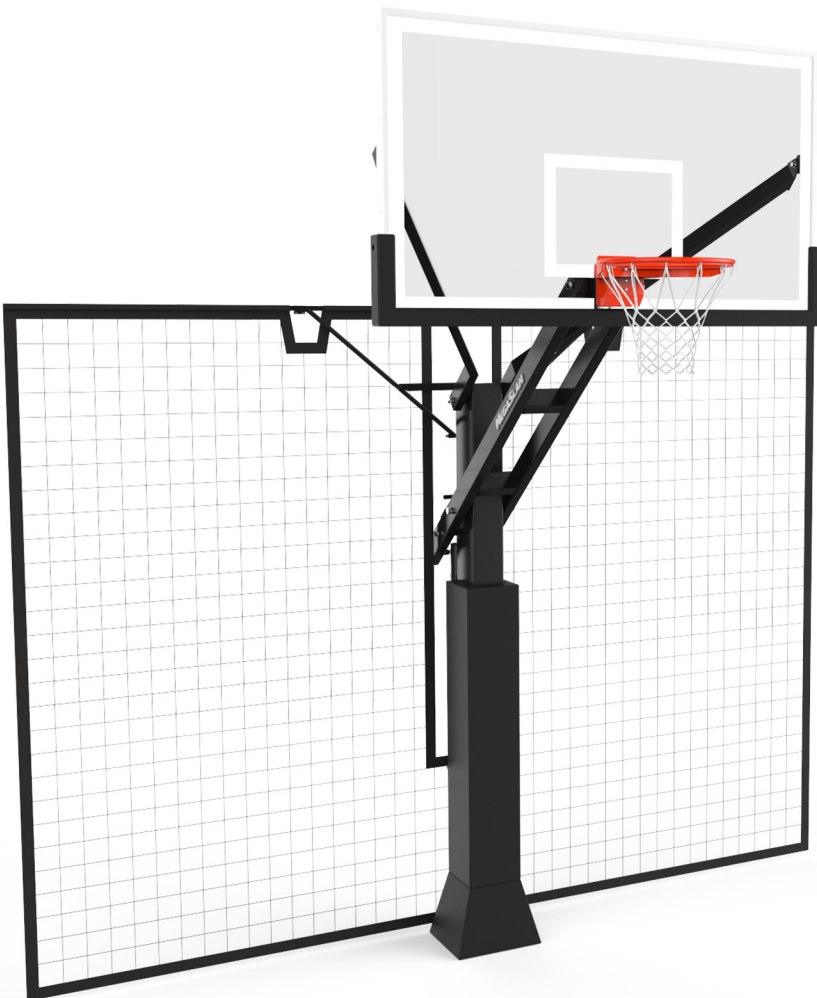

1-877-321-MEGA

www.megaslamhoops.com

Copyright © Mega Slam Hoops, LLC

All rights reserved. Unauthorized copying is prohibited by law without written permission.

TABLE OF CONTENTS

Safety Instructions.....	2
Hardware.....	3
Hardware.....	4
Brace Attachment & Frame Assembly.....	5
Frame Assembly Attachment.....	6
Maintenance & Inspection.....	7

SAFETY INSTRUCTIONS



CAUTION



Owner/Purchaser must insure that all players have read these instructions and both know and follow these rules for the safe operation of the system.

To insure safety, DO NOT attempt to assemble this net system without following the instructions carefully. Proper and complete assembly, use and supervision, and full understanding of the instructions are essential for proper operation and to reduce the risk of accident or injury. A high probability of serious injury exists if this system is not installed, maintained, and operated properly.

Proper and complete assembly, use and supervision is essential for proper operation of the product and to reduce the risk of accident or injury.

Use caution when using this net system. Most injuries are caused by misuse and/or not following these instructions.

Only use parts provided by Mega Slam Hoops, LLC for installation as outlined in this manual as other parts may cause system to fail.

Installation of this product will require some lifting. (2) People in good physical are recommended for safe installation and assembly.

Retain this manual for future reference of operation, maintenance and parts information. The information in this manual is based on the latest information available at the time of publication. Your net system may have product improvements and options not yet contained in this manual. Mega Slam Hoops, LLC reserves the right to make changes at any time without notice or obligation.

Keep water and organic material away from net system as this could cause failure from rust/corrosion. Check system regularly for rust. If surface rust is found, remove the affected part and repaint with exterior enamel paint.

Contact the manufacturer if technical assistance is required. Additional copies of these instructions are available at www.megaslamhoops.com

MEGA SLAM HOOPS, LLC.
1141 N. LOOP 1604 E., 105-117
SAN ANTONIO, TX 78232
877-321-6342
www.megaslamhoops.com



WARNING



FAILURE TO FOLLOW THESE WARNINGS & INSTRUCTIONS MAY RESULT IN SERIOUS INJURY, DEATH, AND / OR PROPERTY DAMAGE

Locate your net system away from potential dangers including trip hazards, high traffic areas, or where a vehicle may be in contact with the system.

To avoid serious injury, DO NOT locate the net system under a power line that may come into contact with the system as it is raised. Power lines should not be present within a 20 foot radius of system.

If using a ladder during assembly, use extreme caution. Follow all warnings and cautions on the ladder carefully.

Use caution when playing in close proximity to this product. During play, do not wear jewelry (rings, watches, necklaces, etc.) or other objects that could become tangled in the net. Wear a dentist approved mouth guard when playing to avoid dental injuries. DO NOT JUMP, CLIMB, OR HANG on the net system or any part of the goal system. This includes the backboard, support braces and net. The product is not designed for such use and property damage or personal injuries such as cuts, broken bones, nerve, spinal cord or brain injury or death could occur.

Do not use the system to support anything and do not attach anything to this product. When adjusting the goal system height, keep hands/fingers away from moving parts. DO NOT ALLOW CHILDREN TO INSTALL / REMOVE NET SYSTEM.

Climate, corrosion, or misuse could result in system failure.

Check system before each use for loose hardware, signs of rust and instability. If the rust has penetrated the steel, replace that part immediately. Repair before each use. Never play on damaged equipment.

Disconnect the net when not in use, especially during bad weather.



**Net Bracket
(1) Piece**



**Center Net Bar
(1) Piece**



**Outer Net Bar
(2) Pieces**



**Support Bar
(2) Pieces**

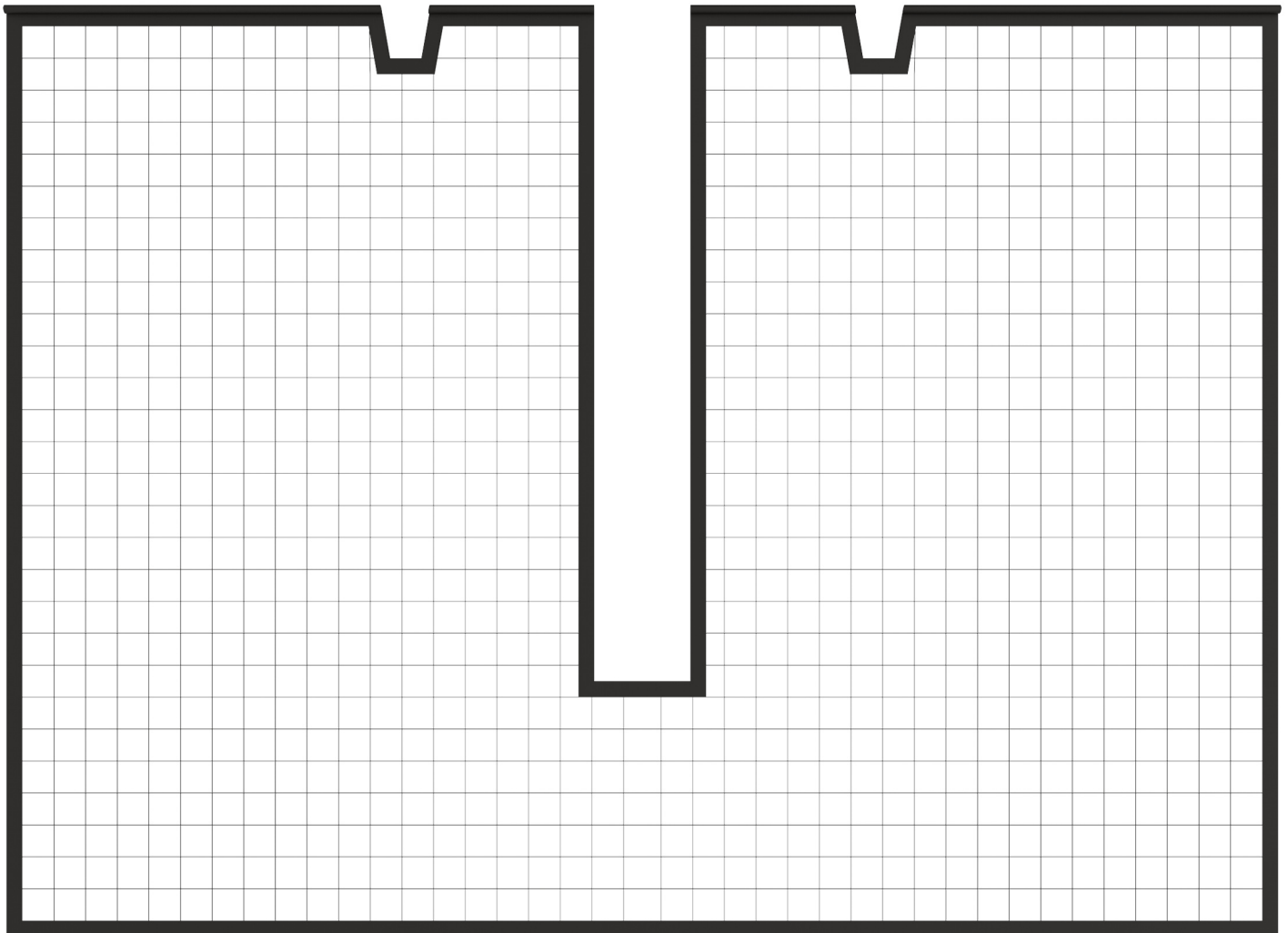

Net

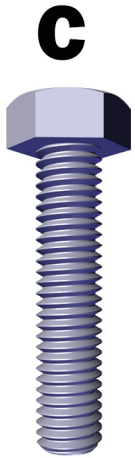

C
8mm x 1.5"
(2) Pieces



D
6mm x 1.5"
(2) Pieces

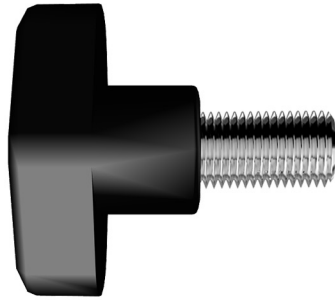

Knob

Mounting Kit Hardware

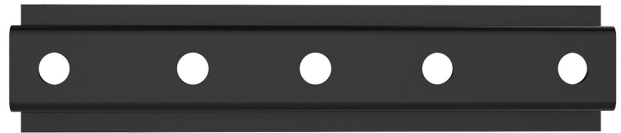

Lower Mounting Brace

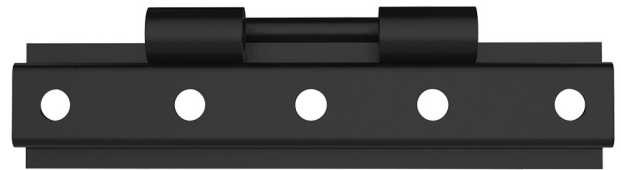

Upper Mounting Brace

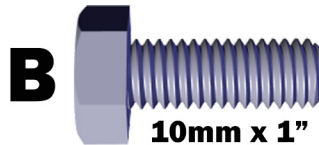

B
10mm x 1"
(2) Pieces



Lower Lock Bracket

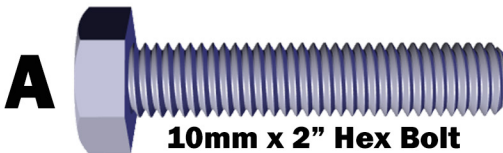

A
10mm x 2" Hex Bolt
(4) Pieces



Y
10mm Hex Nut
(4) Pieces

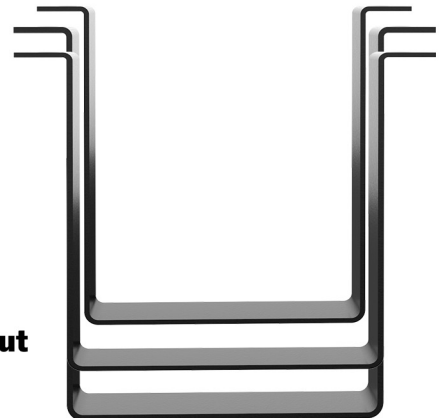

5" x 5" U Bracket - (2)
6" x 6" U Bracket - (2)
8" x 6" U Bracket - (2)

Fasteners



L Pin



E
6mm Hex Nut
(2) Pieces



F
6mm Flat Washer
(4) Pieces



H
8mm Hex Nut
(2) Pieces



K
8mm Flat Washer
(4) Pieces

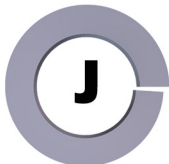

J
10mm Lock Washer
(2) Pieces

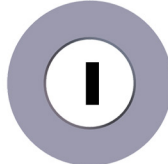

I
10mm Flat Washer
(10) Pieces

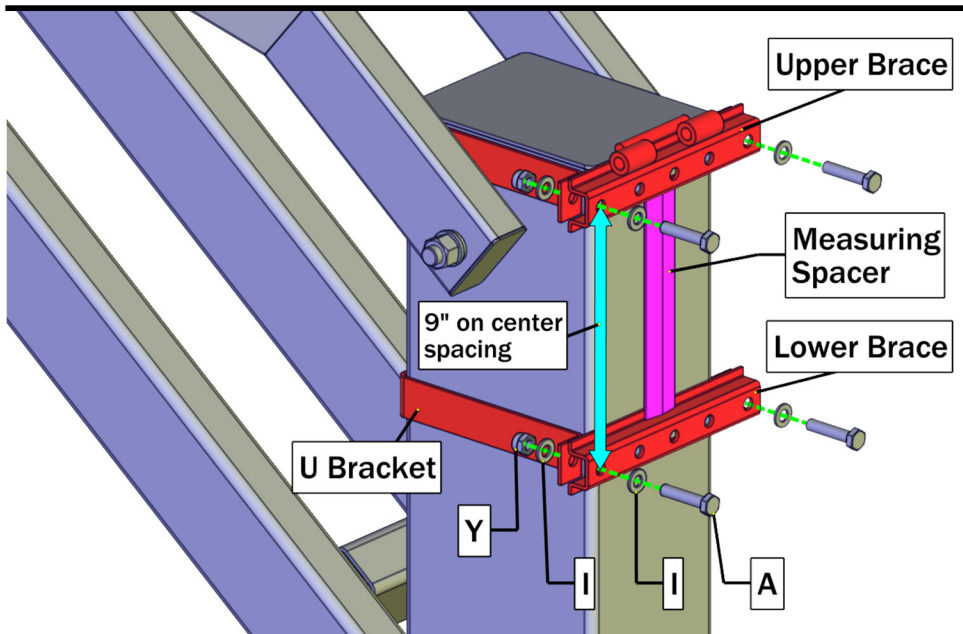

STEP #1 Brace Attachment to Main Pole

First, attach the upper brace to the top of the main pole.

Second, using the measuring spacer make sure the Lower Brace is spaced apart 9" on center from Upper Brace. Once spacing is correct, attach Lower Brace to the main pole using the following:

- "Lower Brace" - (1)
- "Upper Brace" - (1)
- "U Bracket" - (2)
- "A" - 10mm x 2" steel bolt (4)
- "I" - 10mm flat washer (8)
- "Y" - 10mm nut (4)

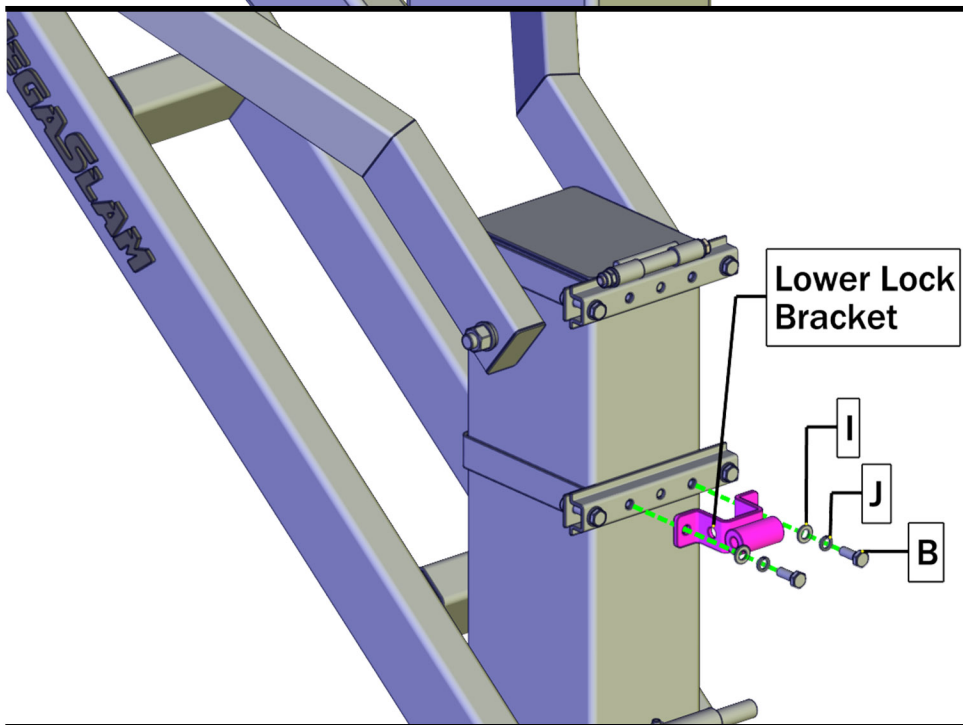

STEP #2 Lower Lock Attachment

⚠ CAUTION

If you also purchased the Game Light™ accessory skip this step, and reference the Game Light™ instructions to complete assembly of both accessories.

If you are only installing the Net Protect™, please proceed with assembly instructions below.

Attach the Lower Lock Bracket using the following:

- "B" - 10mm x 1" bolt (2)
- "I" - 10mm flat washer (2)
- "J" - 10mm lock washer (2)

STEP #3 Net Frame Assembly

Find a large area to assemble the net frame

First, assemble the three-piece framing. Then insert and slide the framing into the sleeve in the net.

Step #1 Assemble Net Framing

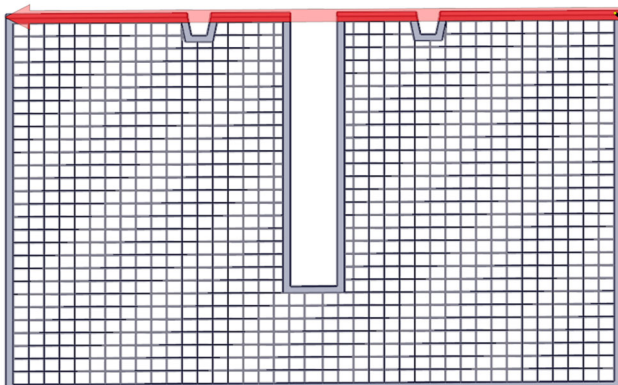

Step #2 Insert Framing into Net

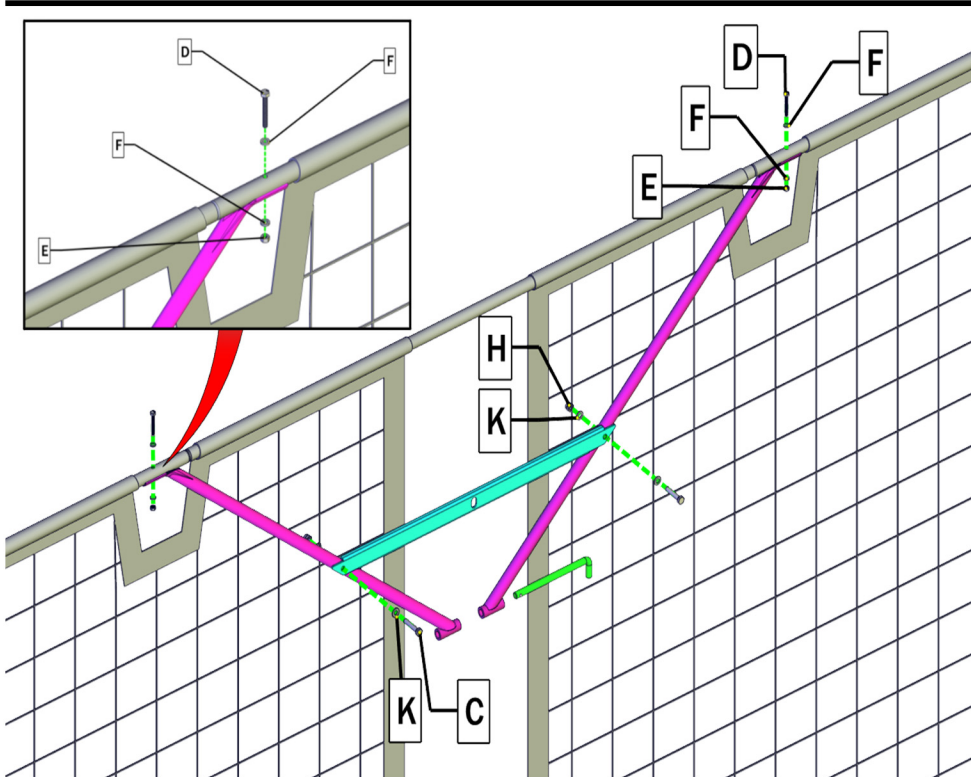

STEP #4

Net Frame Assembly - Part 2

First, attach the (2) Support Bars to the Net Bars. Then attach the Net Bracket to the Support Bars using the following:

“D” – 6mm x 1.5” bolt (2)

“F” – 6mm flat washer (4)

“E” – 6mm hex nut (2)

“C” – 8mm x 1.5” bolt (2)

“K” – 8mm flat washer (4)

“H” – 8mm hex nut (2)

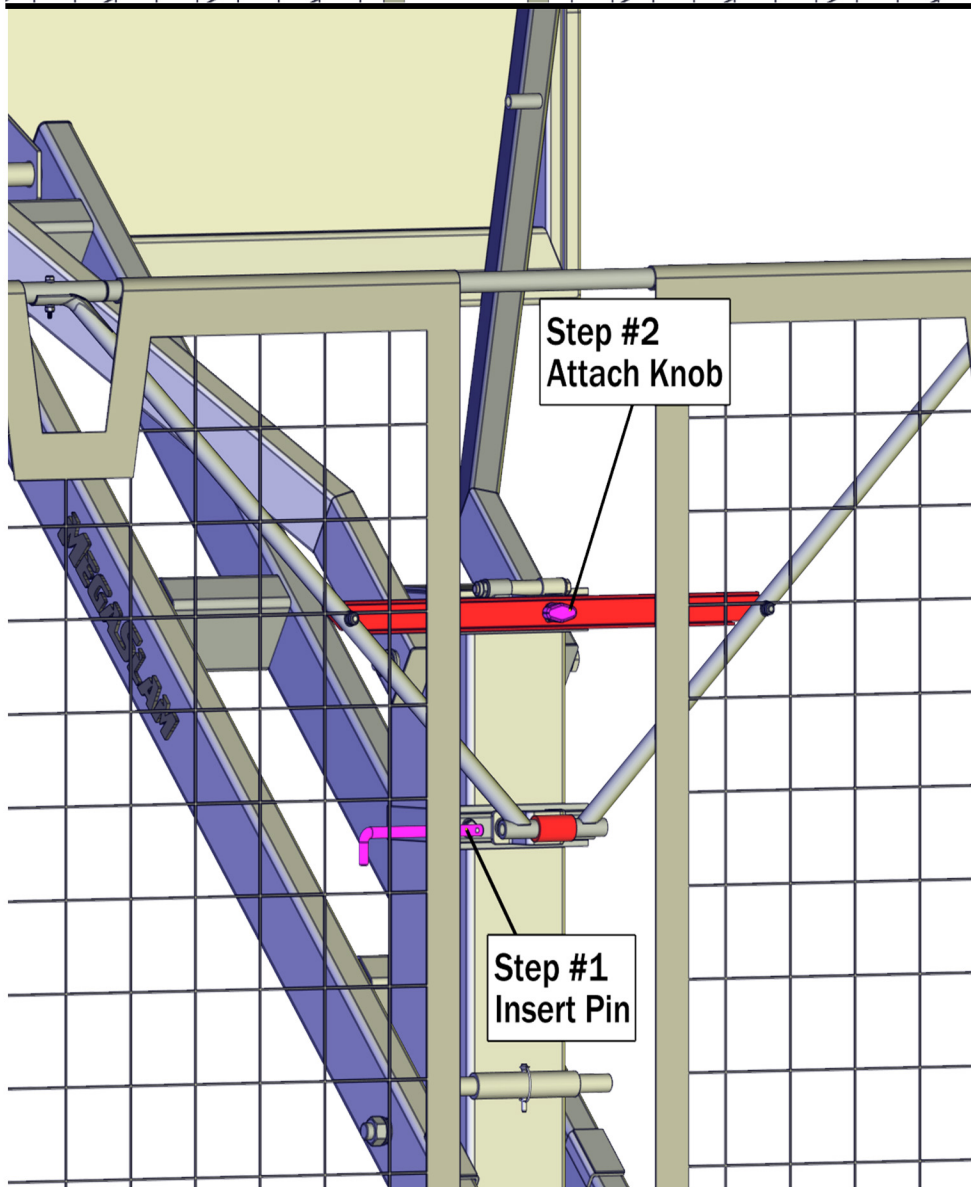

STEP #5

Net Protect™ Attachment to Basketball System

First, insert the pin into the lower lock bracket, then attach the knob to secure the Net Protect™ into place.

Step #2
Attach Knob

Step #1
Insert Pin

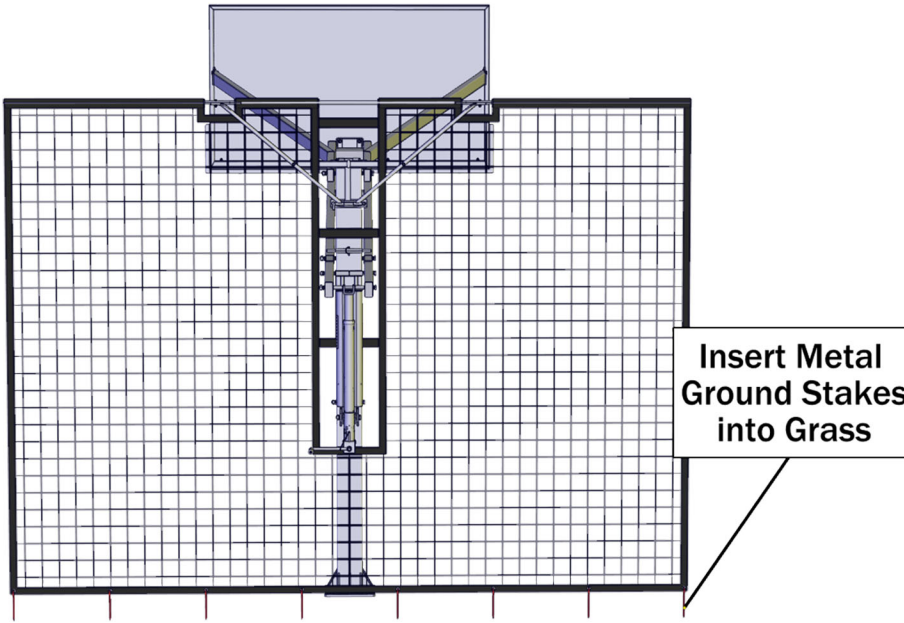

STEP #6

Insert Metal Stakes into the Grass

After securing the net protect to the basketball system, insert the metal stakes into the ground.

CAUTION

Do not climb or jump on product

Disconnect the Net Protect™ when not in use, especially during bad weather.

STEP #7

Maintenance

Like any piece of hardware proper maintenance is required. Several factors such as the environment, organic materials, herbicides, pesticides, excessive use, or misuse can eventually cause the system to require periodic maintenance. Failure to do so could result in system failure, property damage, or even personal injury.

- Keep all organic materials (grass clippings, garbage, etc.) away from the Net Protect™ and basketball system to alleviate any chance of rust penetrating the powder coated finish.
- Clean the Net Protect™ periodically with water and a soft cotton cloth. To properly clean the system components use a soft, non-abrasive cloth and water with a mild detergent. Do not use abrasive materials to clean as it could damage the powder-coated finish.
- If you see any signs of rust on the Net Protect™ or basketball system remove the loose paint, gently sand the area, and apply outdoor enamel gloss paint to the affected area.
- Disconnect the Net Protect™ when not in use, especially during bad weather.

STEP #8

Routine System Inspection

Before each use inspect the Net Protect™ for any signs of the following:

- Loose nuts and bolts
- All parts and components for excessive wear and tear
- Any signs of rust or corrosion

If replacement parts are needed, only replacement parts from Mega Slam Hoops, LLC should be used in the repair process. Use of other parts may cause the system to fail resulting in serious injury or death and will void the manufacturers' limited lifetime warranty.